

Architecture and Design of Adaptive Object-Models

**Joseph W. Yoder
&
Ralph Johnson**

**The Refactory, Inc.
University of Illinois**

yoder@refactory.com

johnson@cs.uiuc.edu

<http://www.adaptiveobjectmodel.com>

Presenter

◆ Joseph Yoder

- e-mail: yoder@refactory.com
- www: <http://www.joeyoder.com>

- www.refactory.com

Table of Contents

- ◆ Overview
- ◆ Adaptive Object-Model Description
- ◆ Architectural Elements of AOM
- ◆ Some Examples of AOMs in Practice
- ◆ Other Issues and Related Architectures
- ◆ Summary

What are we doing?

- ◆ Describing a “new” type of architecture.
- ◆ Not really “new” but only known by a few people. Has not been well described.
- ◆ Going to describe them with patterns.
- ◆ Patterns work together to solve the problem.

Why is this Important?

- ◆ Need to know different architecture styles so as to understand them, know the advantages and disadvantages, when to use them, etc.
- ◆ Software architects usually reuse architectures they understand.
- ◆ Learn through courses, experience, working with someone else, papers, ...
- ◆ Need to know and catalogue and describe in detail different types of architectures.

Meta Collaborators

- ◆ Ali Arsanjani
- ◆ Federico Balauer
- ◆ Krzysztof Czarnecki
- ◆ Martine Devos
- ◆ Brian Foote
- ◆ Martin Fowler
- ◆ Dragos Manolescu
- ◆ Jeff Oaks
- ◆ Nicolas Revault
- ◆ Dirk Riehle
- ◆ Reza Razavi
- ◆ Michel Tilman
- ◆ Others...

Adaptive Object-Models

- ◆ Architectures that can dynamically adapt to new user requirements by storing descriptive (metadata) information about the business rules that are interpreted at runtime.
- ◆ Sometimes called a "reflective architecture" or a "meta-architecture".
- ◆ Highly Flexible – Business people (non-programmers) can change it too.

Context of the Style

- ◆ Requirements change within application's domain.
- ◆ Business Rules are changing rapidly.
- ◆ Applications have to quickly adapt to new business requirements.
- ◆ Changing the application is costly, it generally includes code and data-storage.
- ◆ There are cycles of: build-compile-release.

Forces – Shearing Layers

- ◆ Who (Business Person, Analyst, Developer)
- ◆ What (Business Rule, Persistence Layer,...)
- ◆ When (How often, How fast)

There is a different rate of change
on the system.

Foote & Yoder - Ball of Mud PLoPD4

General Idea

- ◆ Create an object design (meta-model) that describes the domain objects which includes attributes, relationships, and business rules as instances rather than classes.
- ◆ The domain objects are instantiated through a description given by the user or domain expert.
- ◆ Each new requirement is satisfied by creating a new description and a new instantiation.
- ◆ Separate what changes from what doesn't.
- ◆ Define Changes without Hand-Coding.
- ◆ Focus on "What" Not "How".

Adaptive Object-Model

(Active|Dynamic Object-Model)

- An ADAPTIVE OBJECT-MODEL is an object model that provides “meta” information about the domain so that it can be changed at runtime
 - ◆ explicit object model that it interprets at run-time
 - ◆ change the object model, system changes its behavior
- ADAPTIVE OBJECT-MODELS usually arise from domain-specific frameworks
- Business rules are stored as descriptive (meta) information in ADAPTIVE OBJECT-MODELS

Adaptive Object-Models

- ◆ Represents classes, attributes, relationships, and behavior as *metadata*.
- ◆ Based on instances rather than classes.
- ◆ Users change the *metadata* (object model) to reflect changes in the domain.
- ◆ Stores its *Object-Model* in a database or in files and interprets it (can be XML/XMI).

Consequently, the object model is adaptable, when you change it, the system changes immediately.

Metadata and Adaptive Object-Models

"Anything you can do, I can do Meta"

Metadata: If something is going to vary in a predictable way, store the *description* of the variation in a database so that it is easy to change....Ralph Johnson

"Meta is Beta"

Code is Data, Data is Code – Everything is Data

Architectural Elements of Adaptive Object Models

- Metadata
- TypeObject
- Properties
- Type Square
- Entity-Relationship
- Strategy/RuleObjects
- Interpreters/Builders
- Editors/GUIs

If you want something to change quickly,
you must push it into the data.

TypeObject: Problem

- ◆ Making a class representing similar types of information will create structural and data duplication.
- ◆ Making many different classes can make any system hard to maintain; each time a new class is added the system should be updated with the new class and the database updated (new releases).
- *There are many instances of a particular kind of element in the domain with minor differences*

TypeObject: Solution

PLoPD3 - Johnson and Woolf

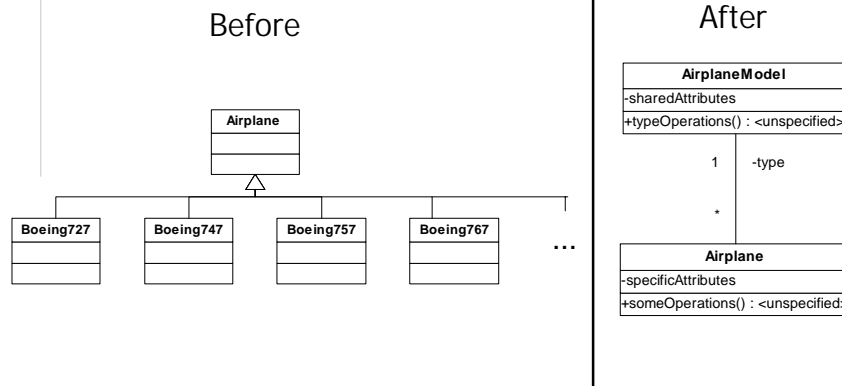

Properties: Problem

- ◆ Making subclasses based on their attributes makes the system static in nature. Each time a new attribute is required, a new class is created, and the system updated.
- ◆ The model will have a prolific hierarchy of classes representing the same domain abstraction or many versions that need to be released to represent the differences.
- *Instances of a given class might have different attributes that may vary at runtime.*

Properties: Solution

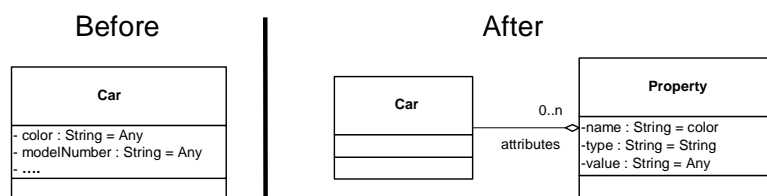

Example: A Store with Catalogue Entries

- Sweaters (size, color, material)
- Canoes (length, material)
- Video Tapes (name, rating, category)

TypeSquare: Problem

- ◆ Fixing the property types information for each property forces the system to be changed each time a property is added or changed on its type.
 - ◆ The system still need to be able to entirely define new high level Types of Properties.
- *The system needs to handle types on dynamic properties and you want to ensure that the types of properties are correct.*

TypeSquare: Solution

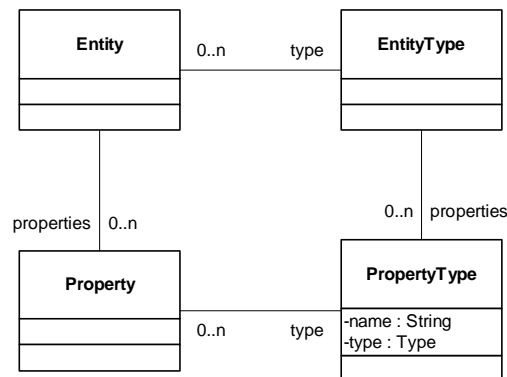

Example: A Store with Catalogue Entries

- Sweaters (size=(S,M,L,XL), color=(red,green,blue,yellow,...))
- Canoes (length=float, width=float)

Entity-Relationship: Problem

- ◆ Elements from the domain can have multiple relationships between them and the system may need to keep track of the relationships including time and other relevant information.
- *The application needs to expose the relationships between domain elements (entities). Each relationship gives roles to the participants. Roles can change and the system needs to know what current roles are being played and are available.*

Newborn Screening

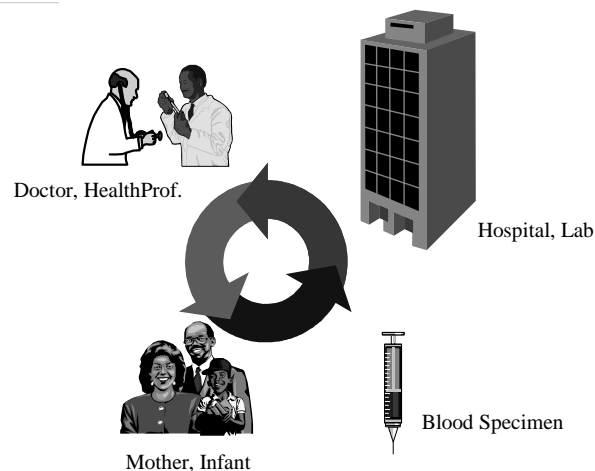

Newborn Screening

Infants, Mothers and Doctors...

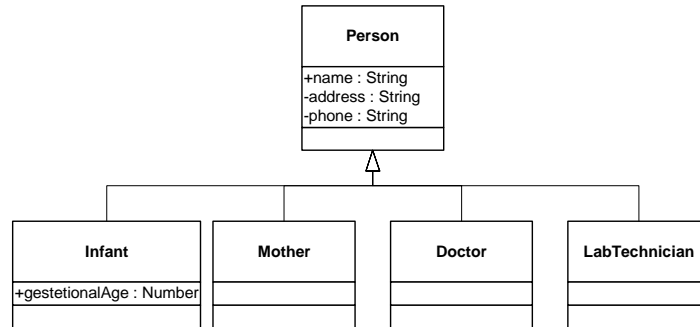

Newborn Screening

Hospital and Lab

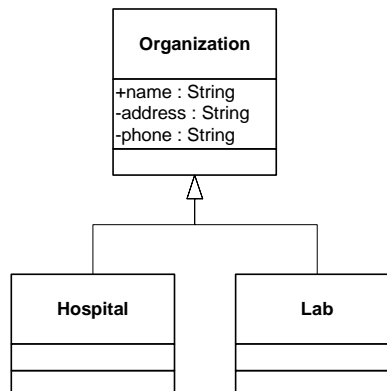

Newborn Screening

Putting it all together

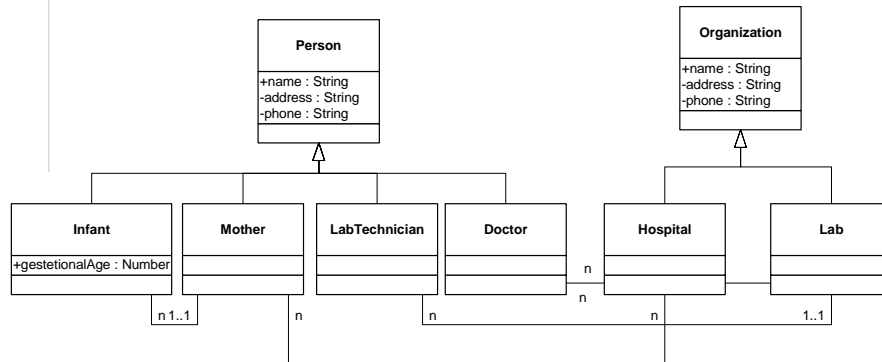

Refugee

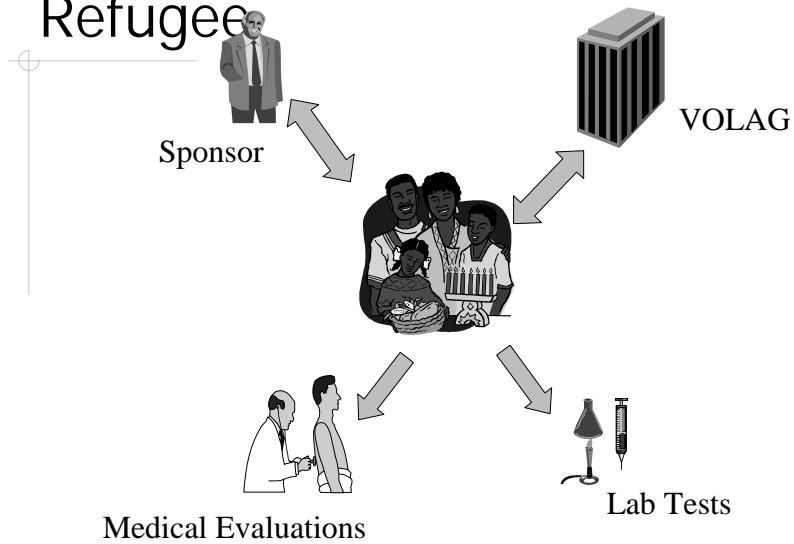

Refugee

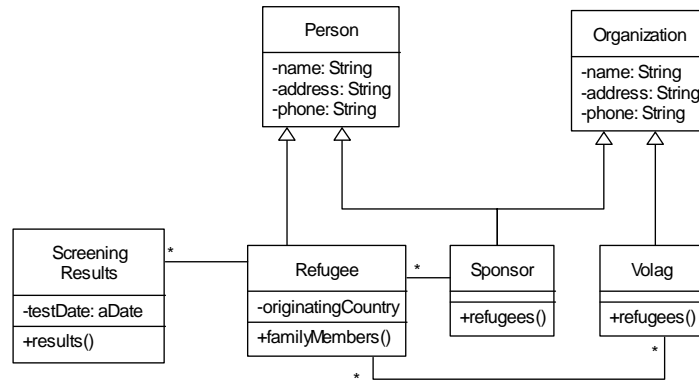

Entity-Relationship: Solution

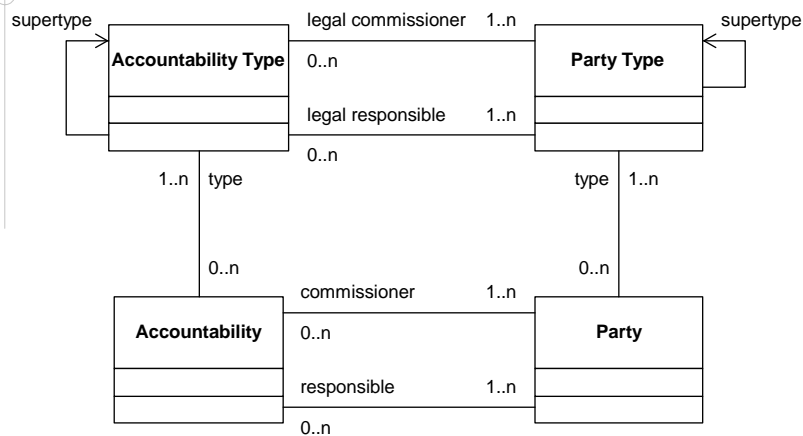

Analysis Patterns - Fowler

Party and Accountability Example



Sue Smith

John Smith



Sue is the mother of John

Party and Accountability (instance diagram)

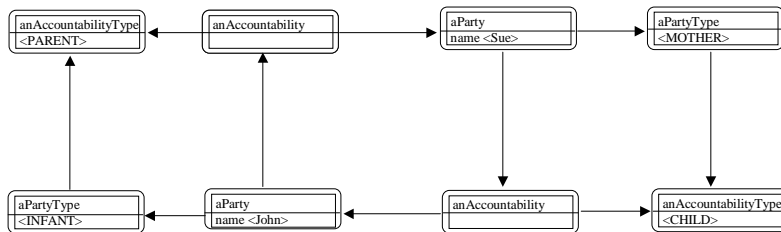

Strategy: Problem

- ◆ Making methods that implement the different algorithm for each Type or Property could require a large case-statement and could be impractical to maintain.
- ◆ Instances for the similar types can have different algorithm depending upon context.
- *The model has to implements a defined set of interchangeable algorithms that customize the behavior of the system.*

Strategies/RuleObjects Solution (Behavior/Methods)

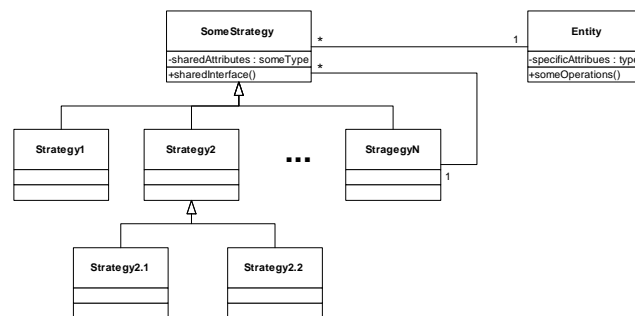

Design Patterns - GOF95

RuleObject: Configurable Strategies

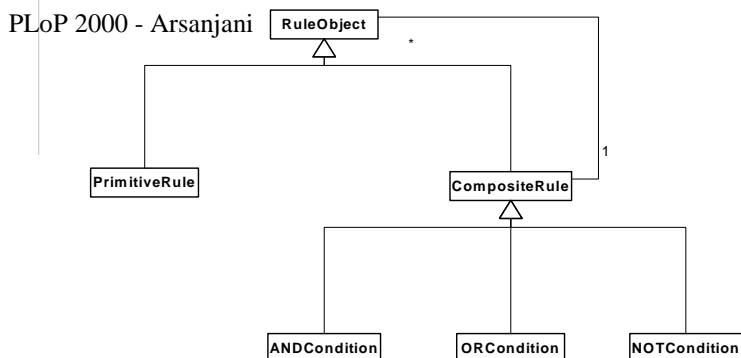

Adaptive Object Model "Common Architecture"

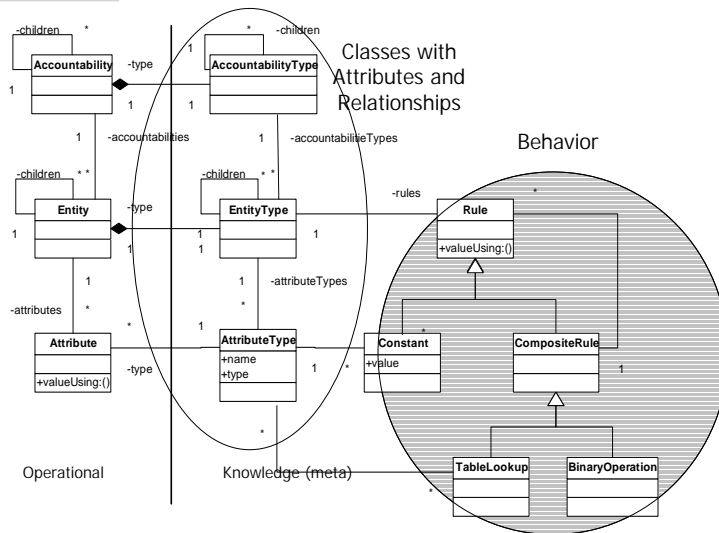

Interpreters / Builders: Context

- *Adaptive Object-Models need to implement ways for describing the types of entities, properties, and relationships as well as ways to create them from this description.*
- *The system also needs a way to interpret the dynamic behavior at runtime such as the strategies or rules.*

Interpreters / Builders: Problem

- ◆ Creating methods in each class for instantiating the required metadata defeats the purpose of taking the AOM approach.
- ◆ The system has to be able to read the metadata any time, and configure itself.
- ◆ The metadata is based on the knowledge of domain experts rather than developers.
- ◆ Rules are based upon descriptive (meta) information

Interpreters / Builders "Virtual Machine"

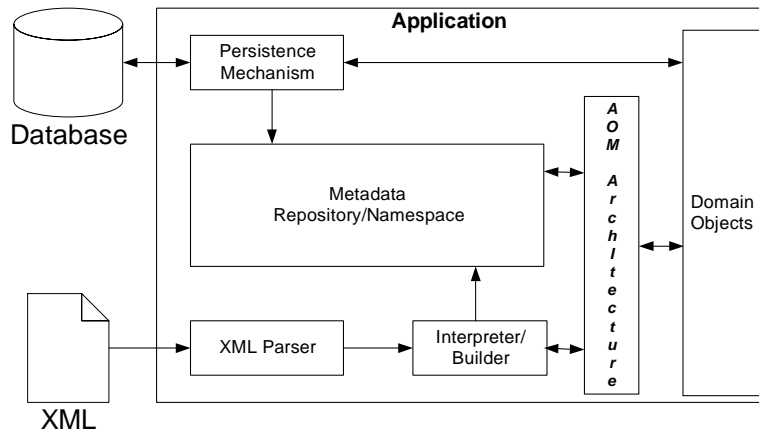

Adaptive Object-Model Examples

Medical Observation - First Model

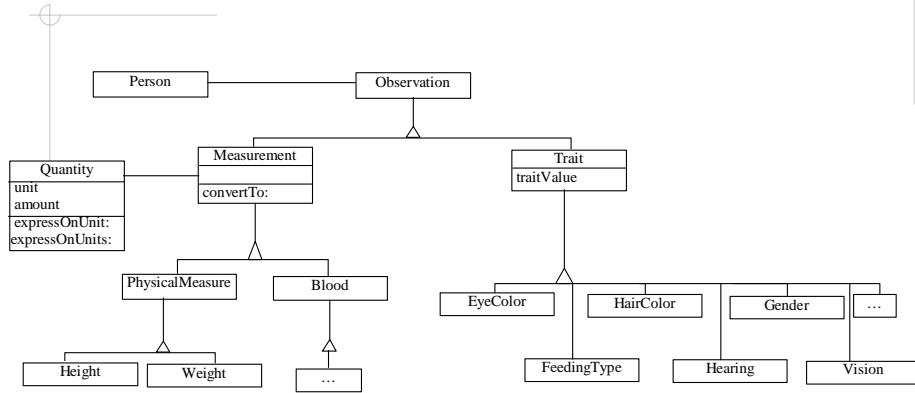

What happens when a new observation is required?

Observation Design

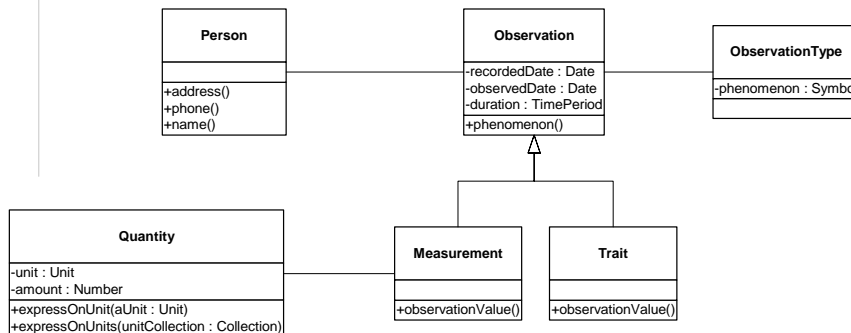

Observation Design

Example

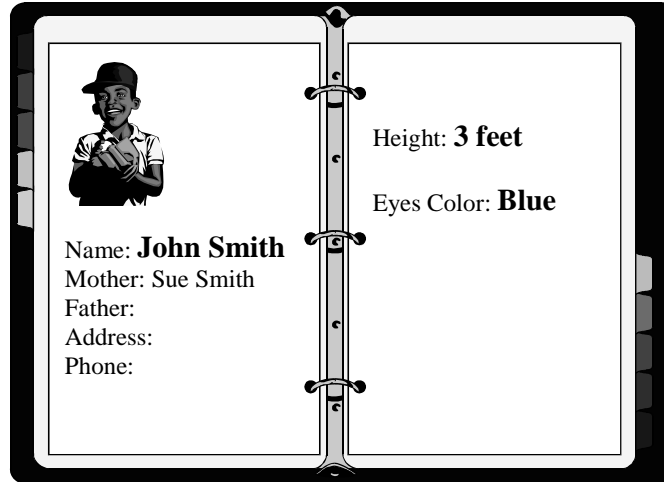

Observation Design

(instance diagram)

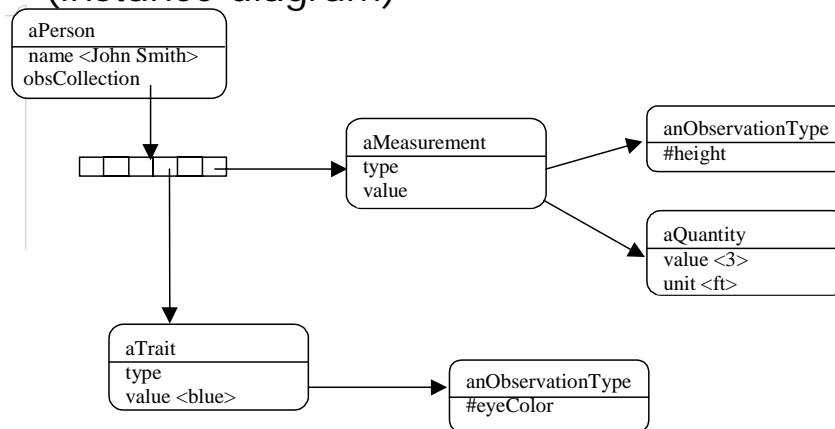

Composing Observations

Observations can be more complex

- ◆ Cholesterol
 - Components: HDL, LDL
- ◆ Blood Pressure
 - Components: Systolic, Diastolic
- ◆ Vision
 - Components: Left Eye, Right Eye

Composite Observation Design

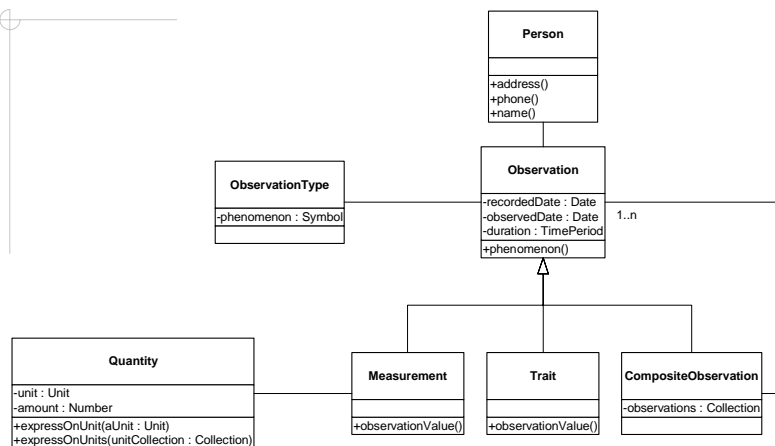

Composite Pattern (GOF)

Observation Design

Example

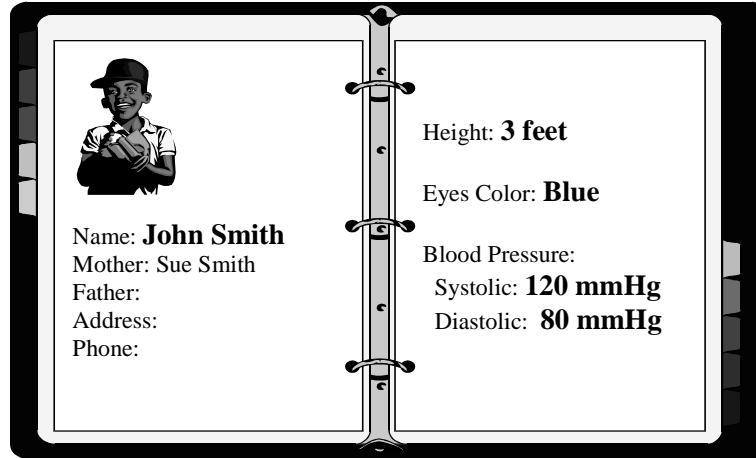

Composite Observation Design (instance diagram)

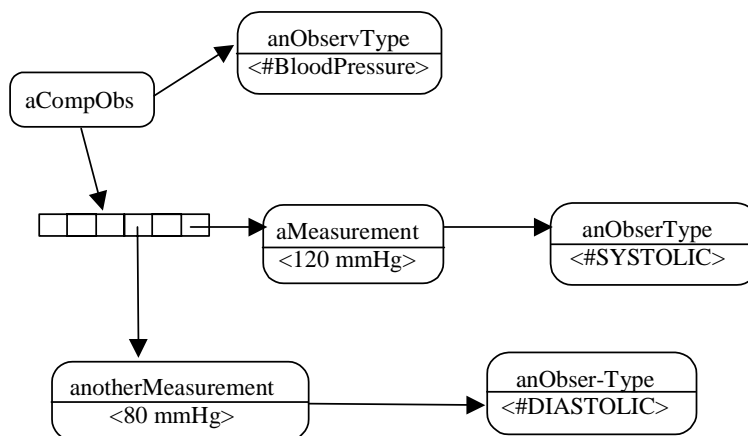

Composite and Primitive Observation Design

What we know about John?

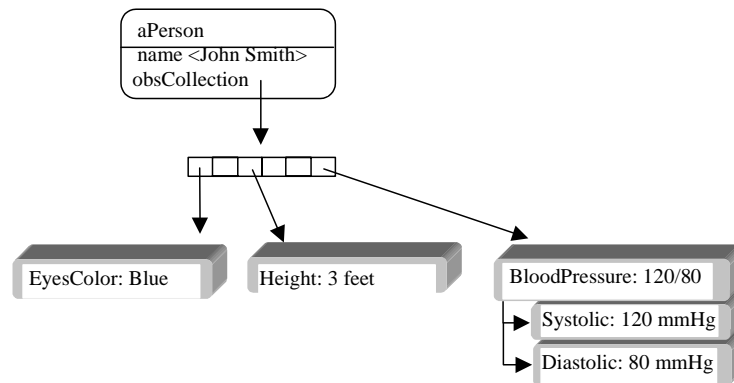

Validating Observations

- ◆ Each Observation has its own set of legal values.
 - Baby's Weight: [0 30] pounds
 - HepatitisB: {positive, negative}
 - Left/Right Vision: {normal, abnormal}
- ◆ GUI can enforce legal values
 - but we want business rules in domain objects

Validating Observation Design

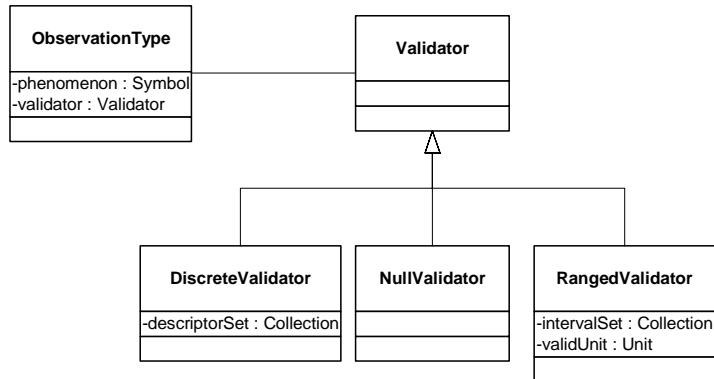

Overall Framework's Design

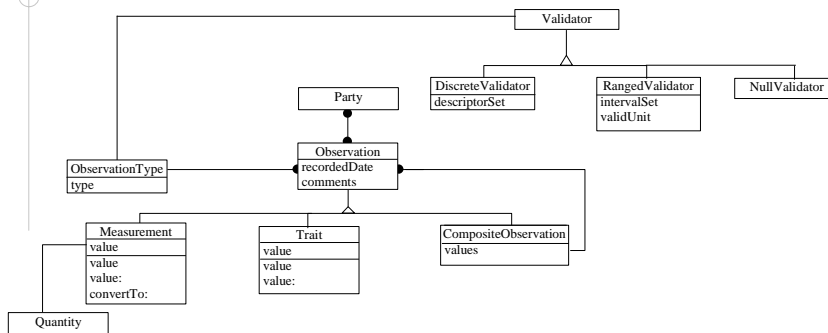

Is everything an Observation?

How does the model specify the structure of the Composite?

What is the relationship between Trait and DiscreteValidator?

Framework's Design

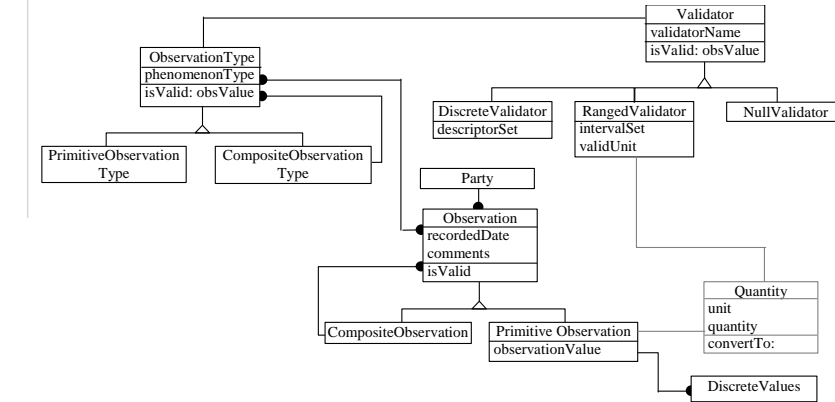

Current Design

Framework's Design

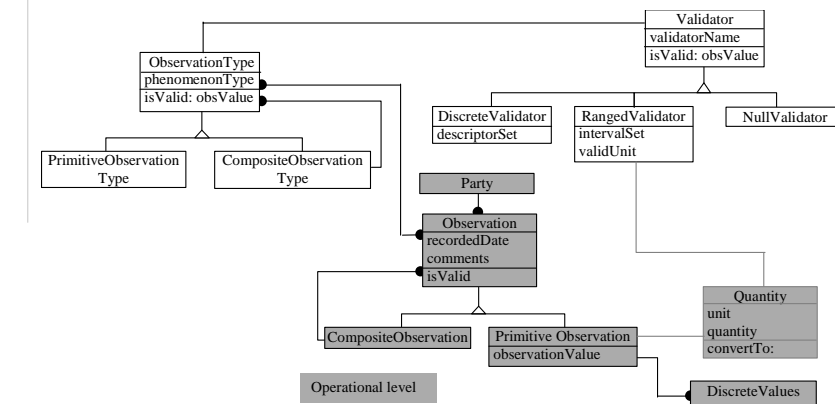

Current Design

Framework's Design

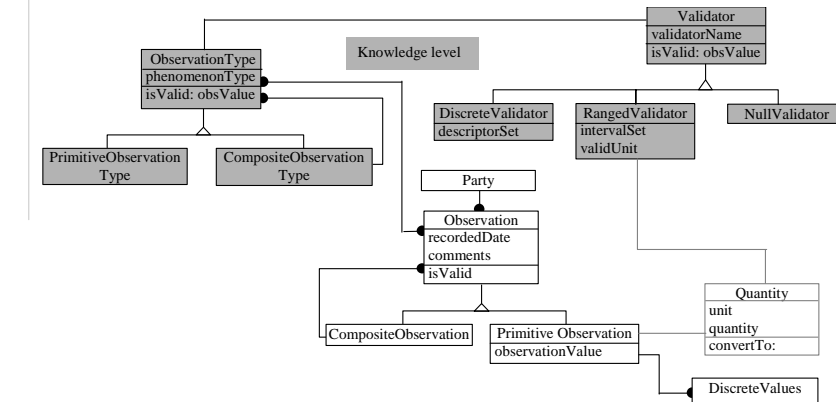

Current Design

Framework's Design

(instance diagram)

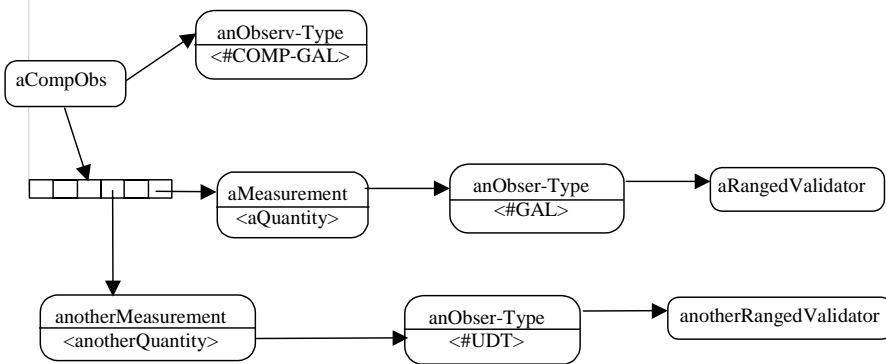

Framework's Design (instance diagram)

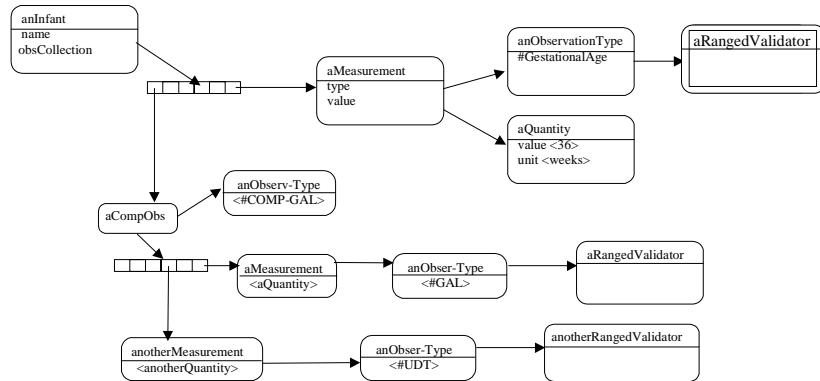

Medical Observation Example

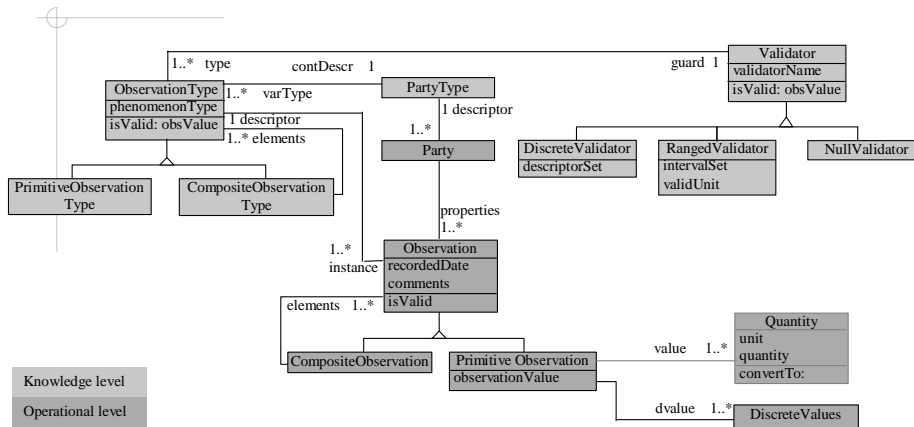

User Defined Product – Example “Hartford Insurance Policies”

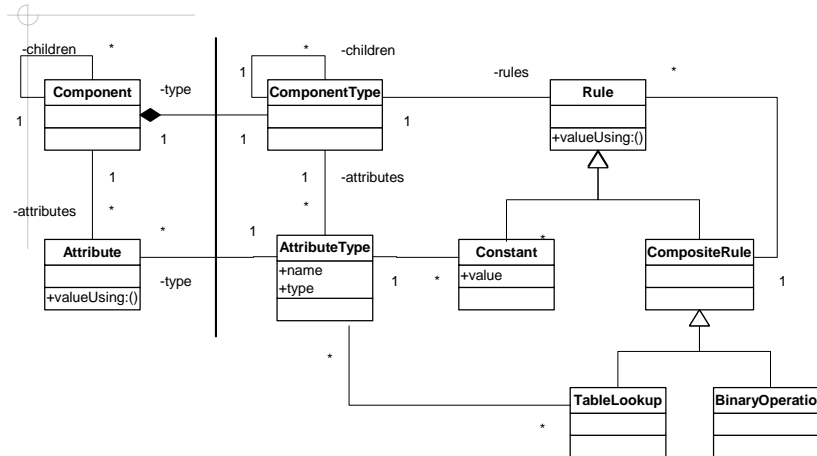

Argos Meta-Architecture (document workflow example)



Argos Business Rule (document workflow example)

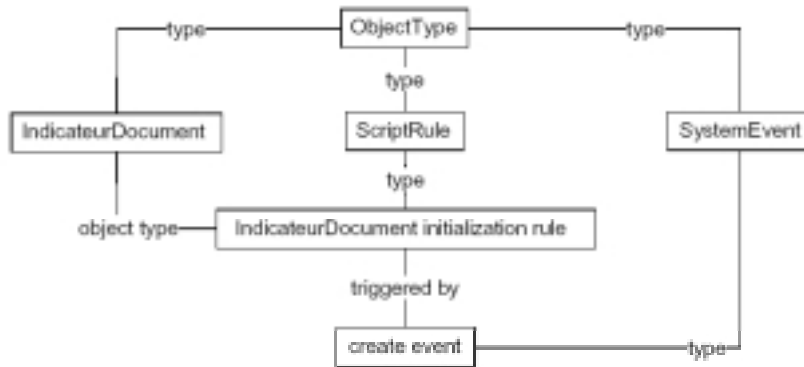

Objectiva Business Entities (telephony example)

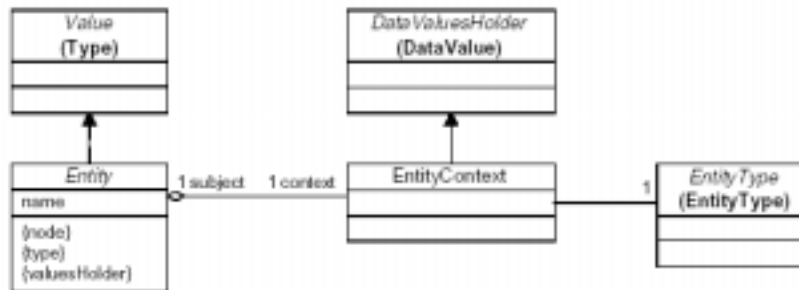

Objectiva Attributes (telephony example)

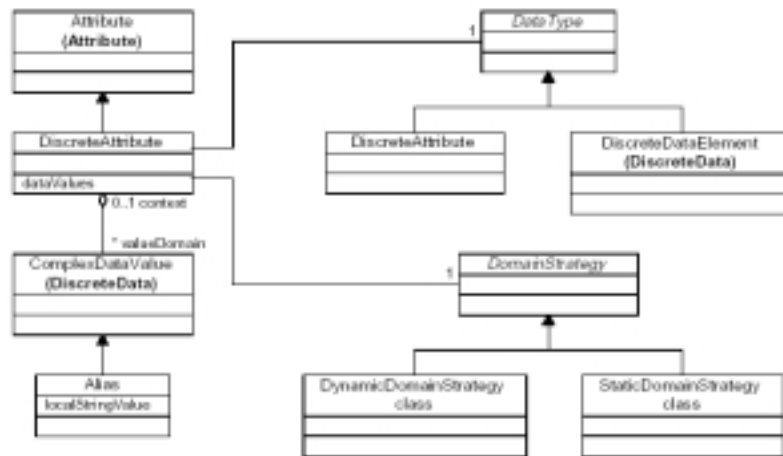

Objectiva Entity Relationships (telephony example)

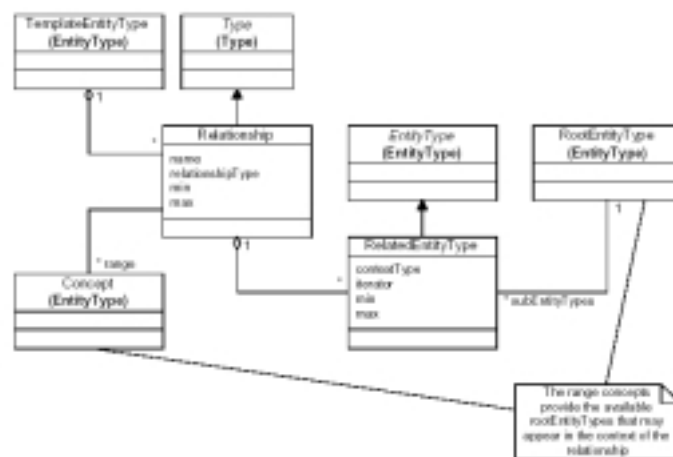

Top Level Dupont Model

Inventories Drilldown "Show calculation for Value"

| | Budget | Actual | Profit +/- | % Change |
|--------------------|-----------------|------------------|-----------------|----------------|
| Prime Products | \$3,273 | \$88,857 | \$77,585 | 2370.00% |
| Production Stores | \$26,000 | \$26,525 | \$525 | 2.02% |
| INVENTORIES | \$29,273 | \$187,382 | \$78,118 | 266.64% |

Vehicles By Marketing Co.

"Summary of Selected Transactions"

The screenshot shows a 'Vehicle Sales Report' window with a 'Vehicle Sales Specification' dialog box overlaid. The report window has a menu bar (File, Window, Help) and a toolbar. The main data area is a table with columns: Family Type, Model Number, Total, NACD, CACO, CAPLH, COGA, and COL. The specification dialog has a menu bar (File, Window, Help) and a toolbar. It has columns: Mfg Src, Family, Model, and Mktg Co. The dialog is currently open, showing a list of models and their corresponding marketing codes.

Detailed Transactions

"Access the individual transactions"

The screenshot shows a 'Query Based Dic: Dup Expenses Actual' window with a menu bar (File, Tools, Window, Help) and a toolbar. The main data area is a table with columns: Date, Family, Section, Account, Seq Key, PCOS Actual, and RD COST. The table contains several rows of transaction data. The window also has a status bar at the bottom with the text 'Move cursor over an item for help information' and 'From: January 1996 To: May 1996'.

Graphing Framework

"Graphs of existing reports or new queries"

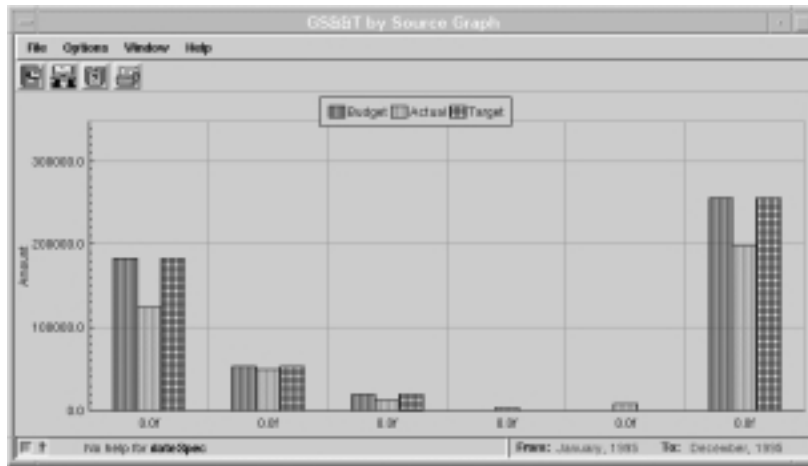

What Happens

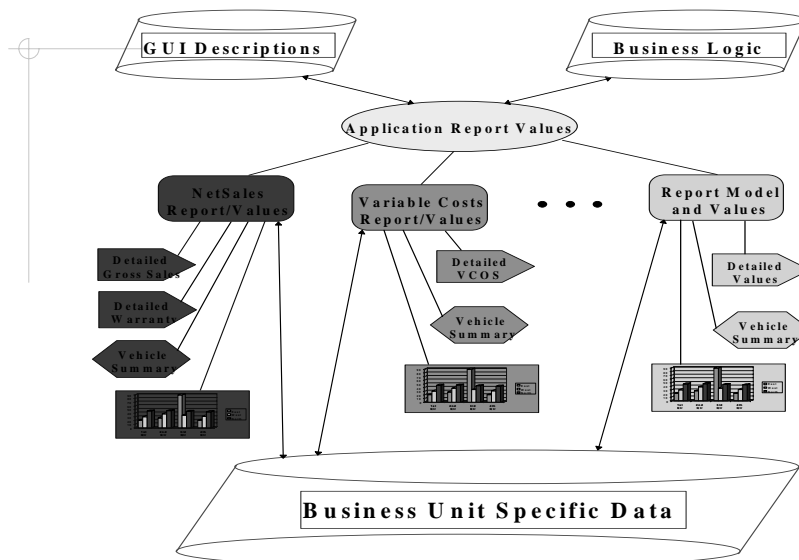

User View Architecture

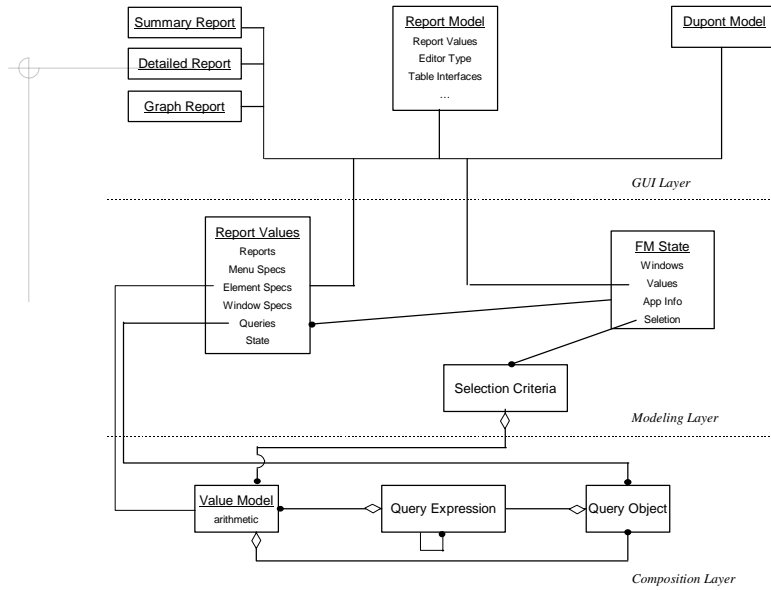

Builder View Architecture

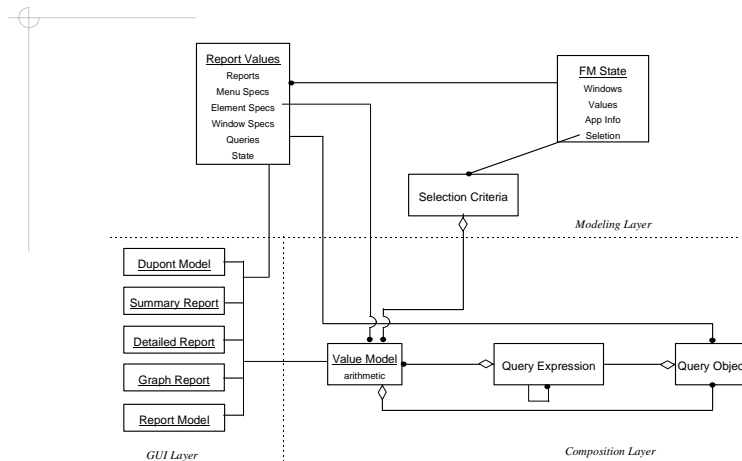

Precautions

Avoid using the metadata for storing:

- Error and warning messages to the user.
- Relationships between classes of the model (example: ObservationType-Validator)
- Variables that are inherent to the design (example: RangeValidator::unit)
- Over design...

Other Issues

- ◆ Consistency (versions)
- ◆ Dynamic GUIs
- ◆ Managing Releases
- ◆ Editors
- ◆ Optimizers

Maintaining consistency (versions)

- ◆ It is important to maintain consistency between the metamodel and any changed instances of TypeObject or other object associated with them.
 - Example: changing the legal range of a Validator can make existing observations invalid.
- ◆ May have to keep version of the metadata available and apply the rules based upon the timeframe the rule applies.

Metamodel and GUI

The screenshot shows a software interface titled "Patient Tracking System". The main window displays patient information for "Clayberg, Zhaiyang". The address is "1734 Reynolds St, Auburn, IL 61301, Champaign County". There are fields for "ID Number" (A023123123) and "ID Type" (Miss Number). Below this, there are fields for "Phone Number" and "Phone Type". The "Vital" section shows "Catholic Church" for "Vital", "Frances Wilson Health" for "Assigned Site", and "Frances Wilson Health" for "Vital Site". The "Physical" section has tabs for "Basic Information", "Medical", and "Physical". Under "Physical", there are fields for "Blood Pressure (mmHg)", "Pulse (beats/min)", "Temp (°F)", "Height", and "Weight". The "Physical" section also includes a table with columns "Ref", "Age", "Description", "Scale", "Ref", "Age", and "Description".

Metamodel and GUI

- ◆ The metadata can simplify building user interfaces. Special GUI components can be developed for using the metadata.
- ◆ Example: The Observation model includes widgets that display list of values from the DiscreteValidators and also EntryBoxes that use RangeValidator.
- ◆ A Mediator and Adaptor layer was developed for managing the interactions between the domain objects and the GUIs.

Metamodel and GUI

- ◆ Generating Dynamic GUIs is Hard!
- ◆ Can generate GUIs using metadata.
- ◆ Special GUI components can be developed for using the metadata.

Managing releases

- ◆ The system has releases because of changes in the metadata not only the code.
- ◆ Changes in the metadata should be checked by running test cases. Use of testing tools is recommended.
- ◆ Versions of the metadata has to be kept.
- ◆ May have effective dates for the rules which are represented by the metadata along with other related history patters.

Related Approaches and Technologies

- ◆ Generative Techniques
- ◆ Black-box Frameworks
- ◆ Metamodeling Techniques
- ◆ Reflection Techniques
- ◆ Domain Specific Languages
- ◆ Table-driven Systems
- ◆ UML Virtual Machine
- ◆ Model Driven Architecture (OMG)

Black-box frameworks

- ◆ These frameworks are instantiated by means of parameterization and object creation.
- ◆ They don't need to have a meta-level.
- ◆ They don't need to have interpreters and builders.
- ◆ They both use very similar patterns (type-objects, properties, strategies, ...)

*AOMs can be Black-box frameworks
but don't have to be--and vice-versa*

Code Generators

- ◆ It provides infrastructure for transforming descriptions of a system into code.
- ◆ Descriptions are based on provided primitive structures or elements.
- ◆ Code generators produce either executable-code or source-code.
- ◆ Can use metadata and editors for describing code to generate.

Metamodeling techniques

- ◆ It focus on manipulating the model and meta-model behind a system as well as supporting valid transformations between different model representations.
- ◆ The attention is on the meta-model, or a model or generating a model, rather than the final application that will reflect the business requirements.
- ◆ This technique is used for describing the domain-specific language.

Domain Specific Languages

- ◆ DSLs can be a scripting language and work by means of parameterization.
- ◆ They don't need to have a meta-level but they often do.
- ◆ They don't need to have interpreters and builders.
- ◆ They both use solving similar patterns, they just might do it in different ways.

*AOMs can be a Domain Specific Language
but don't have to be--and vice-versa*

Table-driven Systems

- ◆ Business rules can be parameterized and stored in a database.
- ◆ The running system can either interpret these rules from a database table or the appropriate function can be called with the differing values from the database.
- ◆ Sometimes these are implemented with triggers and stored procedures.

Model Driven Architecture

- ◆ MDA is highly related to AOMs
- ◆ UML Virtual Machine is an AOM
- ◆ UML Virtual Machine is an MDA approach
- ◆ Focuses more on the modeling perspective

Dimensions of Abstraction

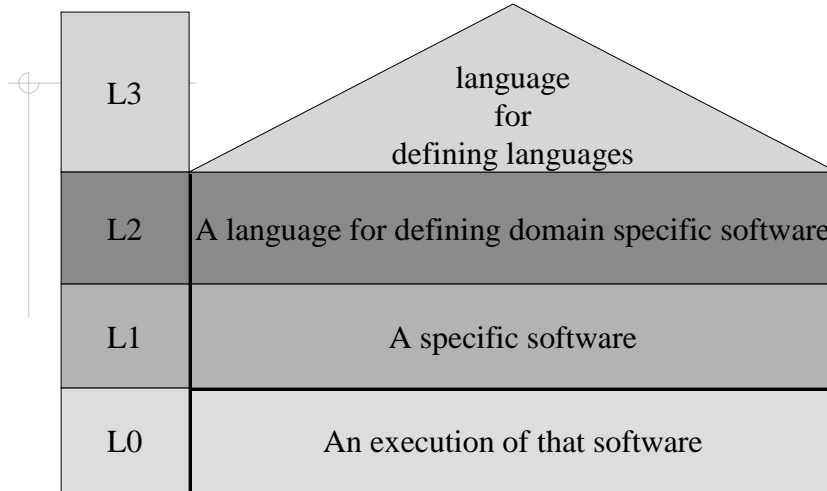

Dimensions of abstraction in Adaptive Object-Models, Reflection and OMG 's metamodeling Architecture

Copyright by ECOOP' 2000 workshop on Adaptive Object-Model. --- <http://www.adaptiveobjectmodel.com/ECOOP2000/description.html>

Architecture and Design of Adaptive Object-Models – August 2003, Brazil. Copyright 2003, The Refactory, Inc.

85

Successfully Used For: (some can be found in papers)

www.adaptiveobjectmodel.com

- ◆ Representing Insurance Policies
- ◆ Telephone Billing Systems
- ◆ Workflow Systems
- ◆ Medical Observations
- ◆ Banking and Trading
- ◆ Validate Equipment Configuration
- ◆ Documents Management System
- ◆ Gauge Calibration Systems
- ◆ Simulation Software

Architecture and Design of Adaptive Object-Models – August 2003, Brazil. Copyright 2003, The Refactory, Inc.

86

Advantages of Adaptive Object-Models

- ◆ Can more easily adapt to new business requirements.
- ◆ Smaller in terms of classes so possibly easier to maintain by experts.
- ◆ Changes do not require recompiling the system.
- ◆ Business People can make changes.
- ◆ Time to market can be reduced.

Disadvantages of Adaptive Object-Models

- ◆ It demands having infrastructure for storing, building, interpreting metadata.
- ◆ Developing AOM can be expensive.
- ◆ Can be hard to understand and maintain.
- ◆ It requires skilled human resources.
- ◆ Can have poor performance.

Process for Developing AOMs

- ◆ Developed Iteratively and Incrementally.
- ◆ Get Customer Feedback early and often.
- ◆ Add flexibility only when and where needed.
- ◆ Provide Test Cases and Suites for both the Object-Model and the Meta-Model.
- ◆ Develop Support Tools and Editors for manipulating the metadata.

*Very similar to Evolving Frameworks
by Roberts and Johnson PLOPD3*

Adaptive Object Model "Common Architecture"

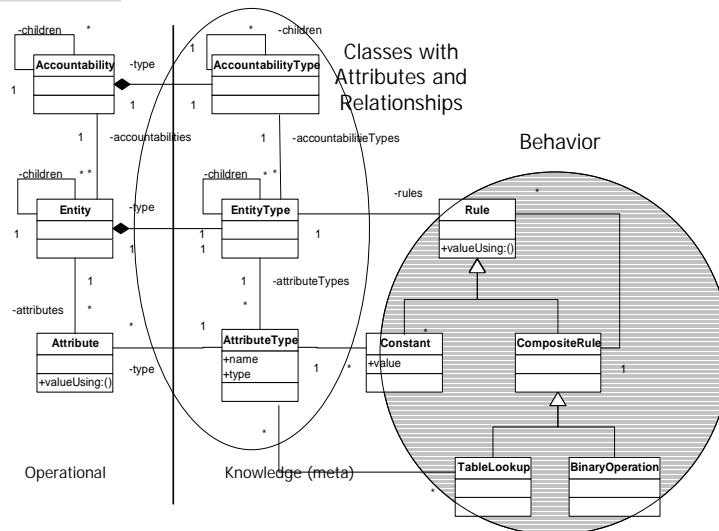

Summary

- ◆ Adaptive Object-Models can take time to develop -- but the payoff can be enormous!
- ◆ Adaptive Object-Models work based upon domain expert knowledge.
- ◆ Adaptive Object-Model architectural style exposes the elements of the domain and business rules.
- ◆ Applying well-known design principles (e.g. TypeObject, Properties, Entity-Relationship, and Strategies/RuleObjects) works well for developing systems that can dynamically adapt to your changing business environment.

Summary

- ◆ AOMs Separates what changes quickly from what changes slowly (hot-spots).
- ◆ Takes into account who changes what, when, and where.
- ◆ AOM Objects constitute a domain specific language.
- ◆ Building languages out of objects can be good...reflection guys say this!

Where to Find More Information

- ◆ <http://www.adaptiveobjectmodel.com>
- ◆ <http://st-www.cs.uiuc.edu/users/droberts/evolve.html>
- ◆ <http://www.joeyoder.com/papers/patterns>
- ◆ <http://hillside.net>
- ◆ <http://st-www.cs.uiuc.edu/>
- ◆ <http://www.refactory.com>

That's All

